

SAS810FHL-7 Thermostat for floor heating

SAS810FHL-7 is a programmable thermostat designed for floor warming application or helping to limit floor temperature. This thermostat can be used for hot water radiant heating systems.

SPECIFICATION:

Power source 100-240VAC 50/60Hz
Relay contact:.....250VAC 16A
Room temperature setting range.....5°C to 90°C
Floor temperature control range..... 5°C to 99°C
Accuracy..... ±0.5°C
Dimensions.....86mm X 86mm X18mm
Color.....White

FEATURE:

- Large LCD display with backlight
 - Permanent user setting retention during power loss,
 - Optional temperature display of Celsius or Fahrenheit scale
 - Optional economic operation or comfort operation
 - Optional type of control for different heating application including room thermostat; floor thermostat or room thermostat with floor limitation
 - Optional programming Period: 7 individual day programming with 48 separate time to select economic or comfort mode.(Every half hour as a period of time) /cancel the programming function.
 - Display temperature recalibrates
-

IMPORTANT SAFETY INFORMATION:

- Always turn off power at the main power source by unscrewing fuse or switching circuit breaker to the off position before installing, removing, cleaning, or servicing this thermostat.
- Read all of the information in this manual before installing this thermostat.
- Only a professional contractor should install this thermostat.
- All wiring must conform to local and national building and electrical codes and ordinances.
- If system is not operating properly, check wiring and replace fuse if necessary.
- Use this thermostat only as described in this manual.

KEYBOARD, DISPLAY AND SWITCH DESCRIPTION

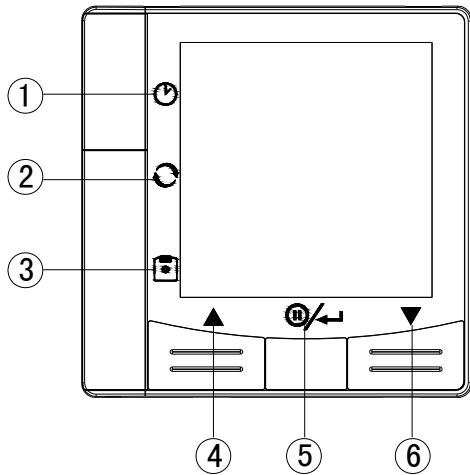

Figure 1

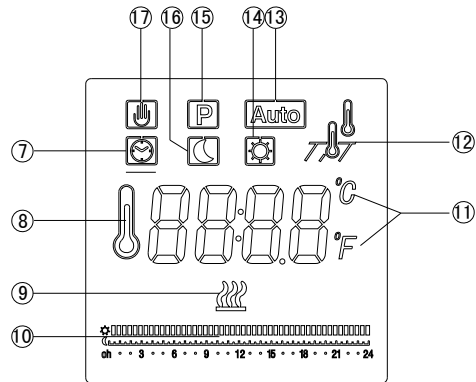

Figure 2

- (1) Clock button : Short press to enter into time setting mode; Hold the time setting button for 2 seconds to enter into floor temperature inquiry interface in dual sensor control mode.
- (2) System button: AUTO mode / Comfort mode /Energy saving mode change over
- (3) Alternative inquiry button for Program setting /Configuration menu option button.
When the display shows OFF stand-by state, Hold button for 3 seconds to enter the configuration menu.
- (4) Raise temperature setting
- (5) Power/OK button, long press power button to enter into **OFF**.
- (6) Lower temperature setting
- (7) Shows clock.
- (8) Shows current room temperature or set temperature or time clock in different mode.
- (9) Shows when there is a call for heating
- (10) Shows current programming time
- (11) Shows temperature display in °C or °F
- (12) (Mode *in*) Shows when thermostat is in room temperature sensor control mode
 (Mode *OUT*) Shows when thermostat is in floor temperature sensor control mode.
 (Mode *RLI*) Shows when thermostat is configured in dual sensor control mode
- (13) Shows when thermostat is in AUTO mode
- (14) Shows when thermostat is in comfort mode
- (15) Shows when thermostat is in program operation.
- (16) Shows when thermostat is in energy saving mode
- (17) Shows when thermostat is in Manual temperature override operation

INSTALL THE THERMOSTAT

ATTACH THERMOSTAT BASE TO WALL

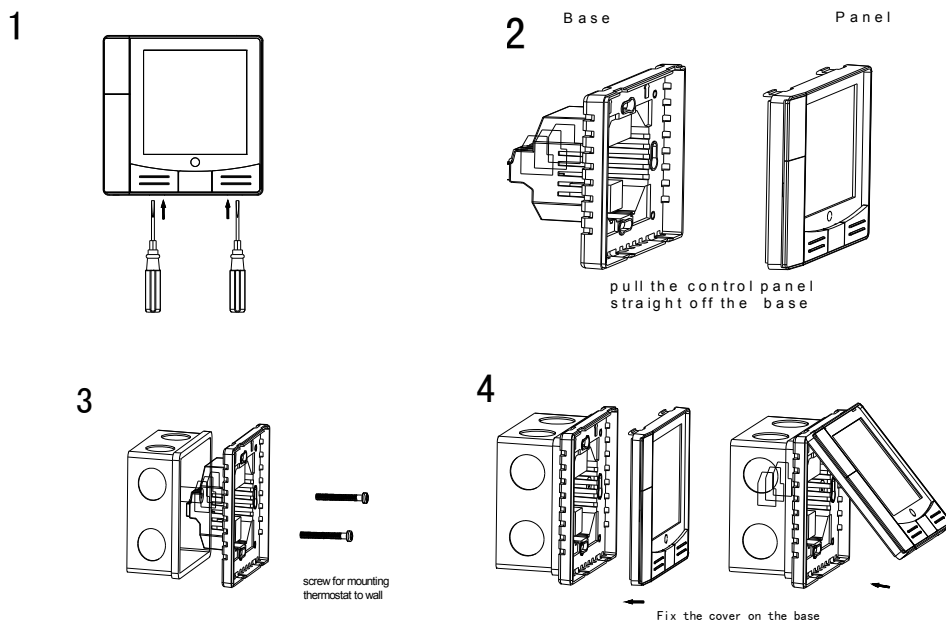

Figure 3

1. Remove the packing material from the thermostat. Gently pull the control panel straight off the base. Forcing or prying on the thermostat will cause damage to the unit. See figure 3-1 & 3-2.
2. The floor sensor cable must be installed to terminal block in heating type F or RF,
3. Connect wires beneath terminal screws on power base using appropriate wiring schematic.
4. Push power base into conduit box. See figure 3-3.
5. Using two mounting screws mount the power base to the wall. Place a level against bottom of base, adjust until level, and then tighten screws. (Leveling is for appearance only and will not affect thermostat operation.)
6. Replace control panel on the power base by snapping it in place. See figure 3-4.

WIRING DIAGRAM

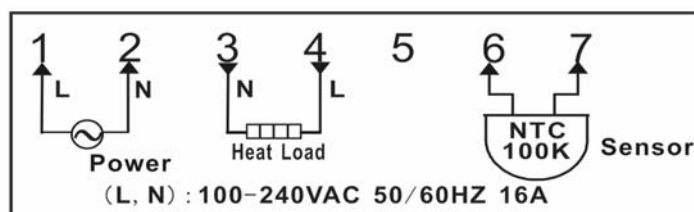

Figure 4

Attention :



N: Neutral Wire ; L: Live Wire.

Item 1-2: Connected with power. Item 3-4: Connected with heating load.

Item 6-7: Connected with sensor (NTC100K).











OPERATION

1. Configuration Menu

The configuration menu allows you to set certain thermostat operating characteristics to your system or personal requirements. When the display shows OFF stand-by state, Hold button  for 3 seconds to enter the configuration menu. The display will show the first item in the configuration menu. Press  button to shift to the next menu item. Use ▲ or ▼ to select.

To exit the menu, press  button. The thermostat will exit the configuration menu if no action within 20 seconds.

Restore factory default setting: In the configuration menu, push  button for 3 seconds. Display will show “dEF” blinking 3 times and return to Menu item 1 indicates all the configuration setting has reverted to factory default setting. The configuration menu chart summarizes the configuration options. An explanation of each option is given below:

Item	Press buttons	Displayed (factory default)	Press ▲ or ▼ to select	Descriptions
1	 3 sec.	CL (0)	-4 --- +4	Select temperature display adjustment higher or lower
2		RH (35.0°)	20°C(68°F)—90°C(194°F)	Select maximum room setting temperature
3		RL (05.0°)	5°C(41°F)—20°C(68°F)	Select minimum room setting temperature
4		FH (40.0°)	20°C(68°F)—99°C(210°F)	Select maximum floor temperature limitation
5		FL (05.0°)	5°C(41°F)—20°C(68°F)	Select minimum floor temperature limitation
6		RF (ALL)	ALL/In /OUT	Temperature control mode option
7		BL (2)	1/2/3	Select display backlight mode
8		EH (FR)	FR/ SL	Select fast heating or slow heating
9		FC (C)	CF	Changes the display readout to Centigrade or Fahrenheit as required
10		Ld (L)	L/HHH	Select output load.
12		PS (7)	0/7	Programme option

1) Select temperature recalibrates adjustment 4LO to 4 HI –

You can adjust the room temperature display up to 4 higher or lower. Your thermostat was accurately calibrated at the factory but you have the option to change the display temperature to match your previous thermostat. The current or adjusted room temperature will be displayed on the right side of the display. The default setting is 0.

2) Select maximum set point

For room sensor control mode, This feature provides a maximum set point temperature for room setting. The default setting is 35°C(95°F), It can be changed between 20°C(68°F) to 90°C(194°F).

3) Select minimum set point

For room sensor control mode, This feature provides a minimum set point temperature for room setting. The default setting is 5°C (41°F), It can be changed between 5°C (41°F) to 20°C (68°F).

4) Select maximum floor temperature limitation

Press ▲ or ▼ button to select you desire maximum floor temperature limitation. It can be changed between 20°C (68°F) - 99°C (210°F), factory default setting is 40°C (104°F). If floor temperature over the limitation, then stop output work.

5) Select minimum floor temperature limitation

Press ▲ or ▼ button to select you desire minimum floor temperature limitation. It can be changed between 5°C (41°F) to 20°C (68°F), factory default setting is 5°C (41°F).

6) Select Type of heating.

There are 3 temperature control modes: Mode *RL*, Mode *in* and Mode *OUT*.

Mode *RL* is room sensor with floor limiter sensor control mode.

To control room temperature in living rooms etc. The thermostat will activate or deactivate the heating system by comparing the set temperature with the actual room temperature and comparing the preset floor temperature limit with the actual floor temperature. The factory default maximum floor limit is 40°C or 104°F. You can change it in configuration menu item 4. Assuming that the floor temperature is below the maximum floor temperature limit, the heating should begin to operate if the set temperature is 1°C or 2°F higher than the actual room temperature.

Mode *in* is room sensor control mode.

A floor sensor is not present, and cannot be installed. The unit will be controlled via room sensor in the thermostat and the thermostat will determine to activate/deactivate heating system by comparing set temperature with room temperature. Press ▲ to adjust thermostat setting above room temperature 1°C or 2°F. The heating should begin to operate immediately.

Mode *OUT* is Floor sensor control mode.

Constant temperature on the floor in bathrooms and other rooms where a comfortable warm surface is required. The unit will be controlled via external floor sensor. It will determine to activate/deactivate heating system by comparing set temperature with actual floor temperature. Press ▲ to adjust thermostat setting above floor temperature 1°C or 2°F. The heating should begin to operate immediately.

7) Select display backlight mode

The display backlight improves display contrast in low lighting conditions. Factory default is 2.

Select 1 the display will keep the light off.

Select 2 the light will be on when any button of the thermostat is touched.

Select 3 the display will keep the light on continuously.

8) Select °F or °C readout.

Changes the display readout to Centigrade or Fahrenheit as required.

9) Select fast heating or slow heating



Select FA to start heating immediately when the set point is 1°C above the room temperature.

Select SL to start heating only when the set point is 3 °C above the room temperature.

10) Select output maximum load.

According to the actually output heating load, to select the corresponding load current.

The factory default setting is . The options are , , 

 load current are 16 (A).  load current is 8 (A).  load current is 3 (A).

11) Select Programme option.

7 indicate 7 individual day programming; 0 indicate cancel the programming function

2. Manual Operation

1) Set current day and time

a) Turn on the thermostat , press  button to enter the time setting.





b) Press  button again, The display will only show minutes flashing

c) Press and hold either 、 until you reach the correct minutes







d) Press  button once again. The display will show the hour flashing.

e) Press and hold either 、 until you reach the correct hour







f) Press  button once again. The display will show the day of the week flashing.

Press 、 until you reach the correct day of the week. Press button  button once. The display will show the correct day of the week and the time. Press button  button once again or any keys are not pressed within 20 seconds, the thermostat will revert to program operation.

2) Inquiry about floor temperature



This feature is only available in MODE . Hold clock  button for 3 seconds, the thermostat will display floor temperature.  Shows when display temperature is floor temperature. Pressing  button to revert to program operation with room temperature shown in the display.  shows when displayed temperature is room temperature. If press  or no key is pressed after inquiry about floor temperature for 20 seconds, the display will be changed from showing floor temperature to show room temperature.

3) Manual temperature override

When users cancel the programming function,  Shows when thermostat is in manual temperature override operation. During this operation, Press  or  until the temperature you want is displayed. Then press button  button or any keys are not pressed within 20 seconds, the thermostat will revert to manual temperature override operation. If the appropriate temperature is above room temperature , the heating should begin to operate immediately. All of the buttons are invalid except  and  buttons.

4) System Button

Shortly hold the system button , the thermostat can select among comfort mode、energy saving mode and Auto mode. Factory default setting for comfort mode in heating is 35°C and energy mode in heating is 20°C.

 Shows indicate you are now in comfort mode .  shows indicate you are now in energy saving mode.

 shows indicate you are now in energy saving mode. Every time you change the setting in comfort mode, the new setpoint will be memorized as the setpoint of the comfort mode. The same to the energy saving mode and Auto mode.

● **Comfort mode**

In comfort mode, using ▲ or ▼ to select the appropriate temperature you want. Then press button  button or any keys are not pressed within 20 seconds, the thermostat will revert to program operation.. If the appropriate temperature is above room temperature , the heating should begin to operate immediately. Then the thermostat will hold the room temperature at the selected setting temperature until the selected setting temperature is changed.



● **Energy Saving Mode**

In energy saving mode, using ▲ or ▼ to select the appropriate temperature you want. Then press button  button or any keys are not pressed within 20 seconds, the thermostat will revert to program operation.. If the appropriate temperature is above room temperature , the heating should begin to operate immediately. Then the thermostat will hold the room temperature at the selected setting temperature until the selected setting temperature is changed.





● **Auto Mode**

In Auto mode, using ▲ or ▼ to select the appropriate temperature you want. Then press button  button or any keys are not pressed within 20 seconds, the thermostat will revert to program operation.. If the appropriate temperature is above room temperature , the heating should begin to operate immediately. Then the thermostat will hold the room temperature at the selected setting temperature until the selected setting temperature is changed.

5) **Planning your program**

This feature is only available in Auto mode. Hold button  for 3 seconds to enter the programming mode. Look at the factory preprogrammed times and system mode that shown in screen. If this program will suit your needs, simply press the  button to begin running the factory preset program.

If you want to change the preprogrammed time and temperature, follow these steps:

- 1). Hold  for 3 seconds. **00:00** flashing (indicating you are now planning the first paragraph of programming on Monday).
- 2) If the system mode is what you need, press ▲ to next time slot. The time will change in 30-minute increments.
- 3) If you want to change the system mode, Press  button again, mode symbol is flashing .Then you can use ▲ or ▼ to select the comfort mode or energy saving mode you want.
- 4) Press  button to the 2nd program period setting.
- 5) If the system mode is what you need, press ▲ or ▼ until the time slot. you wish to program. The time will change in 30-minute increments.
- 6) If you want to change the system mode, Press  button again, mode symbol is flashing .Then you can use ▲ or ▼ to select the comfort mode or energy saving mode you want.
- 7) Repeat 2)~6) to complete the all program period from Monday to Sunday..
- 8) When you have completed entering your heating program, pressing  to revert to program operation.

9) Press both ▲ and ▼ buttons simultaneously for about 2s, can be programmed to restore factory value

Error Code

LO: Below lowest limitation temperature is detected by floor sensor in MODE *OUT* or *ALL*. Thermostat turn on heating system until the floor temperature is over lowest limitation.

HI :Over high limitation temperature is detected by floor sensor in MODE *OUT* or *ALL*. Thermostat shut down all output

Err.1 flashing in the display: Floor sensor short circuit in type *OUT* or *ALL*. Thermostat shuts down all heating output.

Err.2 flashing in the display: Floor sensor not installed or broken in type *OUT* or *ALL*. Thermostat shuts down all heating output.

Err.3 flashing in the display: Room sensor has short circuited. Thermostat shuts down all heating output.

Err.4 flashing in the display: Room sensor is broken. Thermostat shuts down all heating output.

CUSTOMER ASSISTANCE

After reading this guide, if you have any question about the operation of your thermostat, please contact your installer or service provider.